

LED CCT Panel 400W (Bi-Color)

LAMPHEAD CONTENTS

- Lamp Housing
- Diffuser
- M.O. Stirrup with Ø28mm (1-1/8 in.) Spigot
- Power Supply
- Power Supply Holder
- AC Power Cable
- DC Power Cable



LED CCT Panel 400W (Bi-Color)

SPECIFICATIONS

| | |
|-------------------------------------|--------------------------|
| Identity No. | L004BSCP |
| Max. Capacity | 400W |
| Voltage | 45V DC |
| Current | 8.9A @ 45V |
| Color Temp. | Adjustable 2700K - 6000K |
| CRI | >95 |
| TLCI | >95 |
| Dimming Range | 0-100% |
| Control Signal | DMX 512 |
| DMX Channel | 2 |
| LED Life | Approx. 30,000 Hrs |
| M.O. Stirrup | Ø28mm (1-1/8 in.) Spigot |
| Class / IP Rating | 1 / IP 20 |
| Max. Surface Temp. | 60 °C |
| Max. Ambient Temp. | 45 °C |
| Min. Distance to Illuminated Object | 1 m |
| Min. Distance to Flammable Object | 0.5 m |
| Operating Range | +90° - 0° - -90° |
| Weight | 10.0 kg |

ACCESSORIES

Soft Box

Eggcrate

4-leaf Barndoor

P.O. Stirrup with Ø28mm (1-1/8 in.) Spigot

Safety Cable (for lamphead)



Back

Power Supply Holder



POWER SUPPLY

| | |
|-------------------|---------------|
| Input Voltage | 100 - 240V AC |
| Output Voltage | 45V DC |
| Frequency | 50Hz / 60Hz |
| Class / IP Rating | 1 / IP 20 |
| Weight | 2.0 kg |

■ PHOTOMETRIC DATA

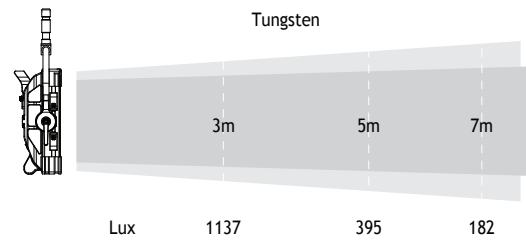
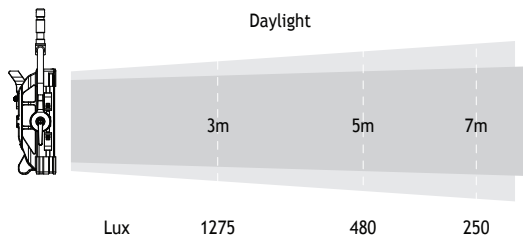

■ SPECTRUM

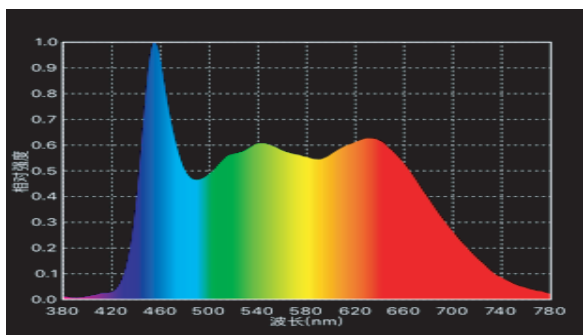

Daylight

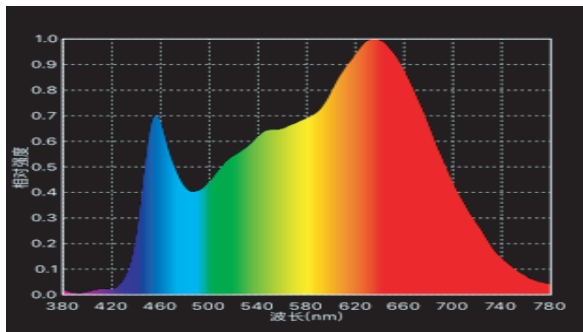

Tungsten

■ HISTOGRAM

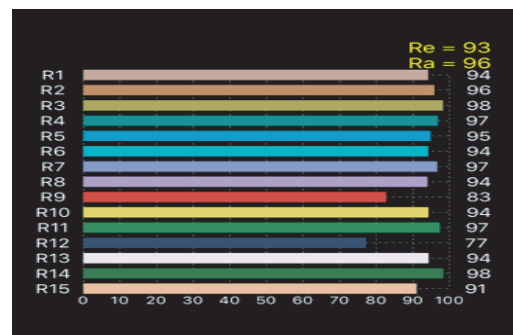

Daylight

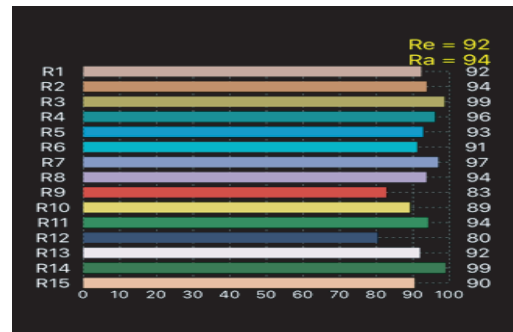

Tungsten

■ DIMENSIONS (mm)

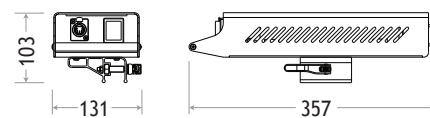
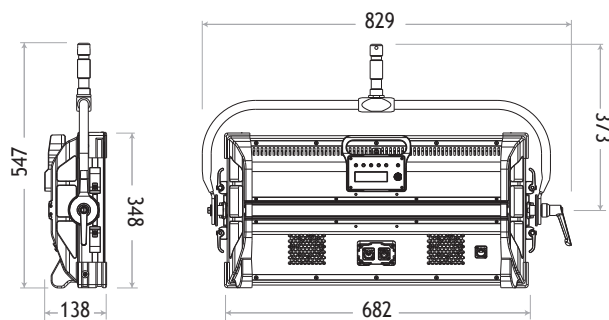

Power Supply